

Installation Manual and Operating Instructions

TRUE BLUE POWER

T12000 SERIES

STATIC ELECTRICAL
POWER INVERTER

Manual Number
9018787



Revision D • May 4, 2020

FOREWORD

This manual provides information intended for use by persons who, in accordance with current regulatory requirements, are qualified to install this equipment. If further information is required, please contact:

True Blue Power
c/o Mid-Continent Instrument Co., Inc.
Attn: Customer Service Dept.
9400 E. 34th St. N.
Wichita, KS 67226 USA
Phone 316-630-0101
Fax 316-630-0723
www.truebluepowerusa.com
www.mcico.com

We welcome your comments concerning this manual. Although every effort has been made to keep it free of errors, some may occur. When reporting a specific problem, please describe it briefly and include the manual part number, the paragraph/figure/table number and the page number. Send your comments to:

True Blue Power
c/o Mid-Continent Instrument Co., Inc.
Attn: Technical Publications
9400 E. 34th St. N.
Wichita, KS 67226 USA
Phone 316-630-0101
Fax 316-630-0723



Download the current version of this installation manual using your smartphone or tablet.

© Copyright 2017
Mid-Continent Instrument Co., Inc.

TABLE OF CONTENTS

<u>SECTION 1</u>	<u>GENERAL DESCRIPTION</u>	<u>4</u>
1.1	INTRODUCTION	4
1.2	TECHNICAL SPECIFICATIONS	5
<u>SECTION 2</u>	<u>PRE-INSTALLATION CONSIDERATIONS</u>	<u>6</u>
2.1	COOLING	6
2.2	EQUIPMENT LOCATION	6
2.3	ROUTING OF CABLES	6
2.4	LIMITATIONS	6
2.5	MODIFICATION	7
<u>SECTION 3</u>	<u>INSTALLATION</u>	<u>8</u>
3.1	GENERAL INFORMATION	8
3.2	UNPACKING AND INSPECTING EQUIPMENT	8
3.3	CABLE HARNESS	8
3.4	MOUNTING	13
3.5	INSTALLATION CAUTIONS	14
3.6	INSTALLATION COMPLETION	14
<u>SECTION 4</u>	<u>OPERATION</u>	<u>16</u>
4.1	ELECTRICAL PERFORMANCE	16
4.2	PROTECTIVE FEATURES	16
4.3	RATED OUTPUT AT ALTITUDE	17
<u>SECTION 5</u>	<u>CONFORMANCE</u>	<u>18</u>
5.1	INSTRUCTIONS FOR CONTINUED AIRWORTHINESS	18
5.2	ENVIRONMENTAL QUALIFICATION STATEMENT	18

REVISION HISTORY

Rev	Date	Detail	Approved
A	08/18/2017	Initial release.	CAS
B	09/14/2018	Added information for 230V and 400Hz models.	CAS
C	11/08/2019	Added notes to 3-phase section, 0.3A input at no load	CAS
D	05/04/2020	Updated style and brand to meet Marketing and Engineering guidelines.	DLR

SECTION 1 GENERAL DESCRIPTION

1.1 INTRODUCTION

The model TI2000 Series Static Electrical Power Inverter is a lightweight power inverter that translates a 20 to 36 VDC input to a variety of application options:

Configurations			
Model	Part Number	Output	Typical Application
TI2000	6432000-1	115 VAC, 60 Hz	General Purpose 115V cabin power
TI2002	6432000-2	230 VAC, 50 Hz	General purpose 230V cabin power
TI2004	6432000-4	115 VAC, 400 Hz	General purpose 400 Hz aircraft power

Table 1.1

All configurations of the Model TI2000 Series provide 2000 watts (VA) of output power. The alternating current output is defined as a pure sine wave with less than 3% of total harmonic distortion for clean, noise-free, harmonic-free power to supply loads of corresponding voltage, power and frequency. For the TI2000, the 115 VAC 60 hertz (Hz) is suitable for nearly any common commercial or consumer load rated for a nominal input of 115 VAC. The TI2002 is designed for a 230VAC output with an AC frequency of 50 Hz for international equipment. The TI2004 is designed to meet 115VAC 400Hz for aircraft system uses.

The TI2000 Series Static Inverter is FAA certified to TSO C73 and tested to rigorous environmental standards and levels of RTCA DO-160G. The small size and light weight in conjunction with its installation flexibility (inside or outside the pressure vessel) make it an ideal choice for aircraft power needs while reducing the challenges associated with other similar products.

Highlighted features include short circuit protection, overload capability, low voltage shut-down, temperature monitoring, a self-resettable over-temperature disable, and a remote on/off function. The rugged extrusion that houses the unit is designed to help dissipate heat and provide mechanical strength against vibration or other possibilities of damage. Two independent fans allow for a smaller unit and quiet operation, and keep the internal components cool extending the life of the unit.

1.2 TECHNICAL SPECIFICATIONS

Electrical Attributes			
	6432000-1	6432000-2	6432000-4
Input Voltage:	Rated 28VDC nominal; 20-36VDC certified.		
Input Power:	80 amps @ 28VDC and 2000W; 0.3 amps at no load		
Output Voltage:	115VAC ±3% at 60 Hz ±0.5% (single phase)	230VAC ±3% at 50 Hz ±0.5% (single phase)	115VAC ±3% at 400 Hz ±0.5% (single phase)
Output Power:	2000 watts (2000 VA at power factor = 1)		
Output Waveform:	Single phase pure sine wave		
Power Factor:	-0.8 to +0.8		
Efficiency:	93% nominal		
Total Harmonic Distortion (THD):	< 3%		

Table 1.2

Physical Attributes	
Weight:	7.7 pounds (not to exceed +5%)
Dimensions: (not including connector mate)	12.00 inches long x 6.32 inches wide x 3.46 inches high
Mating Connector (and cable clamp):	MCI P/N 9018784-1 and 9018550-2
Mounting:	Base mount – orientation not critical

Table 1.3

Qualifications	
Qualification:	FAA TSO-C73
Environmental Qualification:	RTCA DO-160G Environmental Category; See Section 5.2
Altitude:	55,000 ft.
Temperature:	-55°C to +70°C (-67°F to +158°F)

Table 1.4

SECTION 2 PRE-INSTALLATION CONSIDERATIONS

2.1 COOLING

No external cooling is required. The unit is equipped with two internal DC fans. Restriction to airflow can cause overheating of the unit and limit performance or reduce the expected life of the product. Make sure to provide adequate clearance on both ends of the unit with the hexagonal openings to allow for proper circulation. In general, four to six inches of clearance on both ends of the unit should be acceptable. Mounting the unit to a metal surface can also help reduce the effects of temperature within the unit but is not required.

2.2 EQUIPMENT LOCATION

The TI2000 Series Static Inverter is designed for mounting flexibility, allowing for installation inside or outside the pressure vessel with no requirement for temperature control. In addition to altitude and temperature resistance, the unit is also designed to withstand high levels of condensing humidity.

Installation locations where the unit could be subject to standing or direct water exposure should be avoided. The unit can be mounted in any orientation. Clearance should be provided for the mating connector and may require as much as five inches past the unit connector to allow for back shell access to the connector.

2.3 ROUTING OF CABLES

The wires and cable bundle associated with the unit are heavy gauge wire and carry significant power. Be aware of routing cables near other electronics or with other wire bundles that may be susceptible to high energy flow.

Avoid sharp bends in cabling and routing near aircraft control cables. Also avoid proximity and contact with aircraft structures, avionics equipment, or other obstructions that could chafe wires during flight and cause undesirable effects.

2.4 LIMITATIONS

The TI2000 Series of static electric power inverters is certified to FAA TSO-C73 with the following limitations identified:

1. Alternating current (AC) output is provided at 115 volts and 60 Hertz in lieu of 115 volts and 400 Hertz as identified in the MPS of the TSO. This applies to the TI1200 models. Performance complies fully with all tests and requirements of the MPS of the TSO accordingly.
2. Alternating current (AC) output is provided at 230 volts and 50 Hertz in lieu of 115 volts and 400 Hertz as identified in the MPS of the TSO. This applies to the TI1202 models.
3. Alternating current (AC) output is provided at 115 volts and 400 Hertz as identified in the MPS of the TSO. This applies to the TI2004.
4. Equivalent environmental qualification was verified per RTCA DO-160G in lieu of those identified within the MPS of the TSO.
5. Output power is limited at high altitude and temperature per Figure 4.1.

The conditions and tests for TSO approval of this article are minimum performance standards. Those installing this article, on or in a specific type or class of aircraft, must determine that the aircraft installation conditions are within the TSO standards, specification of the article, and deviations as listed above. TSO articles must have separate approval for installation in an aircraft. The article may be installed only according to 14 CFR part 43 or the applicable airworthiness requirements.

2.5 MODIFICATION

This product has a nameplate that identifies the manufacturer, part number, description, certification(s) and technical specifications of the unit. It also includes the “MOD” or modification number representing notable changes in the hardware design of the unit.

Modification (MOD) 0 is the initial release of the product and is identified on the nameplate by the lack of marking on the MOD numbers 1 through 9 (i.e. 1-9 are visible). All subsequent modifications are identified on the nameplate by the marking/blacking out of that particular MOD number (i.e. for MOD 1, the number 1 is not visible and 2-9 are visible - see Figure 2.1 for examples). MODs do not have to be sequentially inclusive and may be applied independent of each other.

For additional details regarding specific changes associated with each MOD status refer to the product published Service Bulletins at www.truebluepowerusa.com.

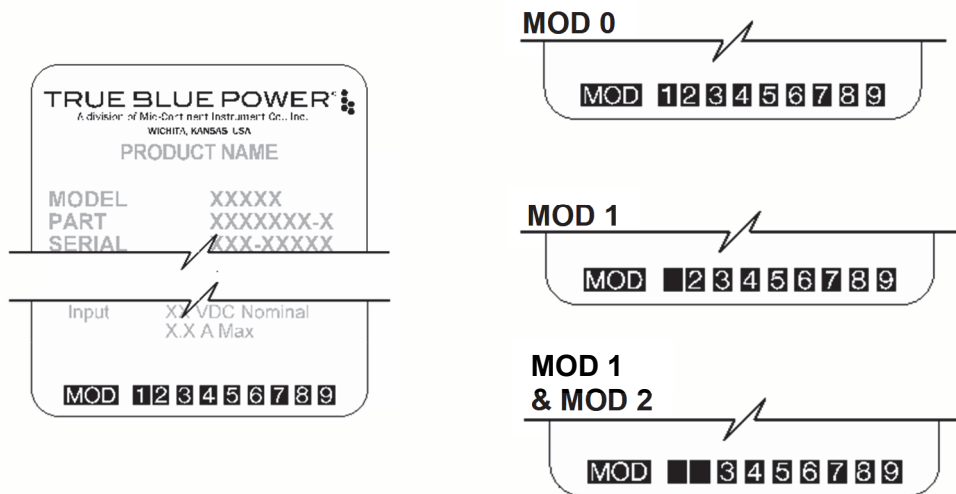

Figure 2.1
Nameplate and MOD Status Example

SECTION 3 INSTALLATION

3.1 GENERAL INFORMATION

This section contains interconnect diagrams, mounting dimensions and other information pertaining to the installation of the TI2000 Series Static Inverter. After installation of cabling and before installation of the equipment, ensure that power is applied only to the pins specified in the interconnect diagram.

3.2 UNPACKING AND INSPECTING EQUIPMENT

When unpacking this equipment, make a visual inspection for evidence of any damage that may have occurred during shipment. The following parts should be included:

- | | |
|------------------------|---------------------|
| A. Static Inverter | MCI P/N 6432000-() |
| B. Installation Manual | MCIA P/N 9018787 |

Available Equipment:

- | | |
|-------------------------------------|---------------------------------|
| A. Mating Connector (& cable clamp) | MCI P/N 9018784-1 and 9018550-2 |
|-------------------------------------|---------------------------------|

Equipment not provided:

- | | |
|-----------------------|---|
| A. Cable Harness Wire | See Section 3.3 for specifications |
| B. Mounting Hardware | four (4) ¼-20 pan head screws
¼" lock washers (optional) |

3.3 CABLE HARNESS

Construct the cable harness with regards to the instructions below, and using the Connector Pinout of Figure 3.3, Table 3.3, and Wiring Diagram of Figure 3.4.

Refer to Section 2: Installation Considerations in regards to routing precautions.

3.3.1 Wire Gauge Selection

Use of PTFE, ETFE, TFE, Teflon, or Tefzel insulated wire is recommended for aircraft use. The following wire gauges are recommended for each of the pins in the connector:

- Pin A and G - 6 AWG stranded
- Pin B and D - 24 AWG stranded
- Pin C and E - 14 AWG stranded
- Pin F - 16-24 AWG stranded

3.3.2 Pin Assignment Information

3.3.2.1 Input Power

(Pin A) Positive DC input – +20 to 36 VDC. Connect to the aircraft 28 VDC bus.
(Pin G) Negative DC input – Internally the VDC Return pin is connected to the inverter enclosure. Connect to aircraft ground.

Note: Two common methods for the connecting the negative DC input of power devices in aircraft are:

1. The negative lead connects from the device to the negative power bus.
2. The negative lead connects from the device to the negative power bus, and a second lead connects to the aircraft structure close to the power device.

The TI2000 Series passes DO-160G Section 21 conducted emissions testing using both methods as listed in Section 5.2 of this report.

3.3.2.2 Inverter Output

(Pin C) AC Output – 115VAC, 60Hz, 400Hz or 230VAC, 50Hz. Used for powering devices where terrestrial/utility power designations are used, this would be connected as “Line” or “Hot”.

(Pin E) AC Return – Used for powering devices where terrestrial/utility power designations are used, pin E can be connected as “Neutral”.

3.3.2.3 Circuit Breakers on Inverter Output

Installation of circuit breakers on the DC input and AC output is recommended. Select values appropriate for the application requirements, with particular consideration for the chosen wire sizes.

3.3.2.4 Three-Phase Communication

(Pin B and Pin D) RS485P and RS485N – Use a twisted pair to connect these to the master unit (Phase A unit) to synchronize operation as a three-phase system.

3.3.2.5 Inverter Remote On/Off Control (see section 4.2.1)

(Pin F) Remote ON/OFF Enable Control – Connecting this pin to DC Return (pin G) will enable the AC output of the inverter. Install a switch to allow remote on/off control of the unit. This pin is internally pulled to 11VDC with a limit of 1mA.

3.3.2.6 Fault Status

(Pin H) Fault – Grounded output signal, typically connected to an indicating LED or lamp, showing that the unit is experiencing a fault condition

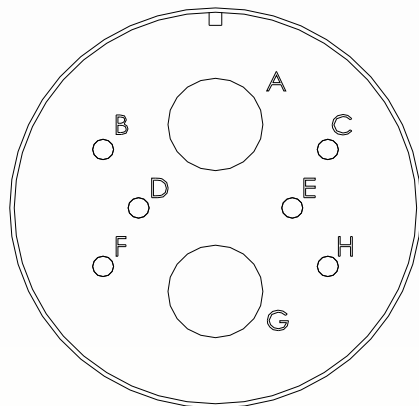

Figure 3.1
Pinout View of Unit Connector

Connector Pinout	
Pin #	
A	20-36VDC Input
B	RS485P
C	VAC Output
D	RS485N
E	Output Return
F	Remote On/Off
G	VDC Return
H	Fault

Table 3.1
Connector Pinout

3.3.3 Use with GFI, Noisy Electronics, and Other Earth/Neutral Situations

The TI2000 series of inverters is fully electrically isolated from the DC input as indicated by TSO-C73, and provides a balanced AC output where AC output and AC return are not associated with the inverter case ground. This is different from terrestrial AC systems where Neutral is connected to ground at an AC distribution transformer at the power mains. Some consumer items contain internal power supplies that require an Earth-Neutral connection for their noise filters to work properly. Similarly, some GFI protection will not function properly if there is not an Earth/Neutral connection or if there is noise between Earth and Neutral.

If consumer video electronics exhibit noise interference, if touch-screen devices exhibit erratic touch-screen operation, or if added GFI systems exhibit false-tripping, then it is recommended to place a capacitor between the inverter AC return (pin E) and the inverter chassis ground or airframe. This capacitor can be located anywhere between the inverter output and the further-most AC outlet. A film capacitor, metalized polyester or metalized polypropylene with a value between 0.047uF and 0.1uF rated for at least 200VAC (for 115VAC inverter output voltage) or 300VAC (for 230VAC inverter output voltage) can be used.

3.3.4 Wiring Examples

The wiring diagrams of Figure 3.4 provides general examples of typical installations. The configuration of individual aircraft installations may vary.

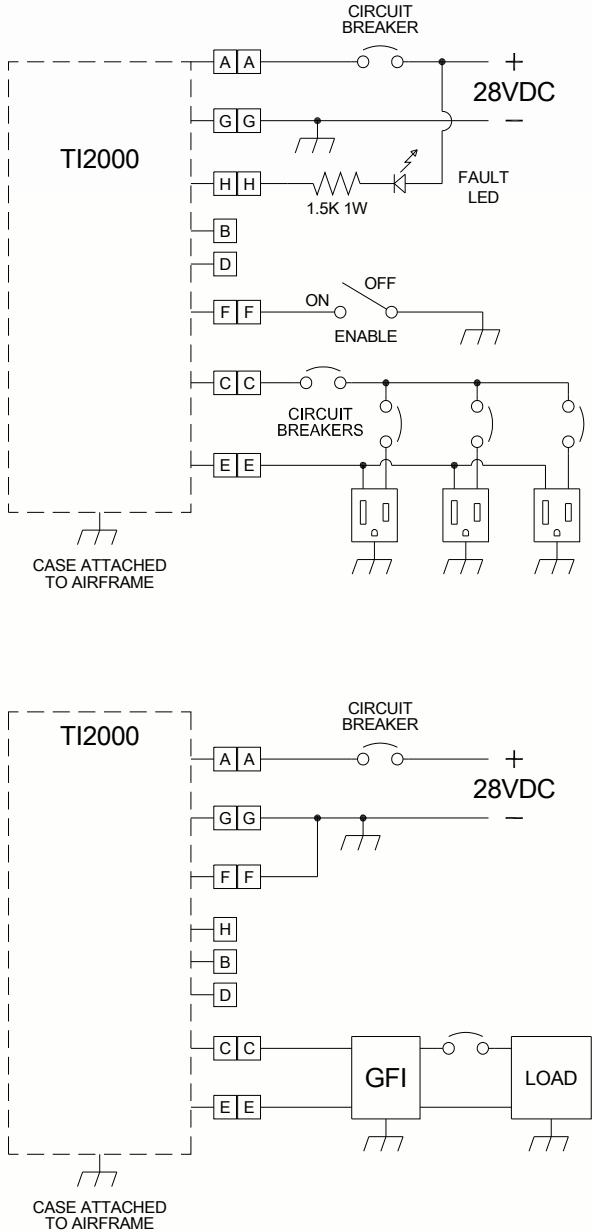

Figure 3.2
Example Wiring Diagrams

3.3.5 Three-Phase Configuration

The TI2000 series of inverters are capable of operating in a three-phase configuration by using three units interconnected as shown in figure 3.4. Connect the RS485P and RS485N pins to each unit, and set the unit phase switch to the correct positions. The switch is located behind the decal cover located in the middle of the fan intake side of the unit as shown in figure 3.5. The switch must be set before applying power. For single-phase / solo operation, the switch must remain in position 1.

For three-phase operation, REMOTE ON must be permanently connected to DC return. System must be controlled through the application of DC power to the three units simultaneously. External monitoring of individual units FAULT outputs and/or power outputs is recommended to ensure all three phases are operating normally.

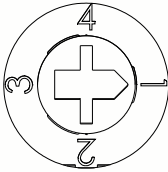

Figure 3.3
Phase Switch

Phase Switch	Phase
1	Single Phase (Solo)
2	Phase A (Master)
3	Phase B (Slave)
4	Phase C (Slave)

Table 3.2
Phase Configuration

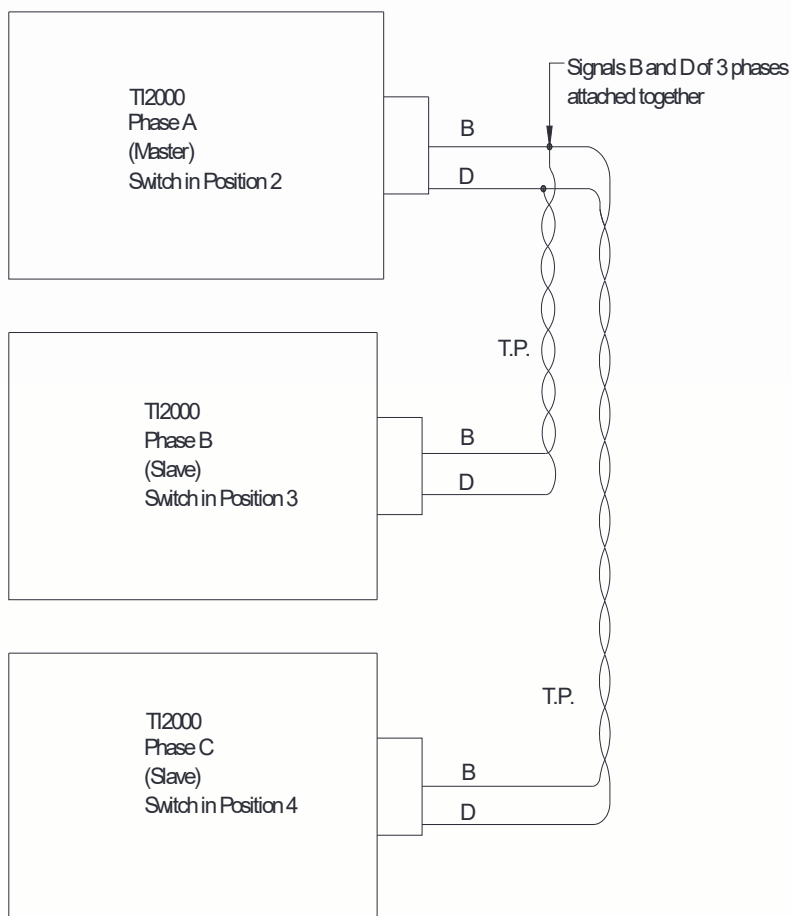

Figure 3.4
Example Three Phase Interconnection

3.3.6 Harness Verification

With the TI2000 Series Static Inverter disconnected, activate the aircraft power bus that supplies the unit and use a multi-meter to verify that aircraft power and ground with appropriate voltage is on the pins within the mating harness.

3.4 MOUNTING

Refer to Section 2: Installation Considerations in regards to equipment location.

The TI2000 Series Static Inverter is designed for base mounting only (in any orientation). Four ¼-20 mounting holes should be provided in the aircraft in accordance with Figure 3.5. Secure the unit with four ¼-20 pan head Phillips screws, or equivalent. A lock-washer under the head of each screw is recommended.

3.5 INSTALLATION CAUTIONS



The TI2000 is not protected against reverse polarity on the input 28VDC. Verify the voltage polarity on the connector before connecting to the TI2000 for the first time.

The TI2000 inverter does not have the ability to phase sync the output to other AC power sources. Do not connect the output of the TI2000 to any other inverter or AC source or damage to the TI2000 will result.

NOTE – Digital meters measure AC voltage with a very high impedance. As noted in Section 3.3.3, the TI2000 has a balanced AC output that is not referenced to the chassis. If a digital meter is used to measure the AC output to chassis, the reading will correspond to approximately half of the inverter rated output voltage. This reading may vary depending upon the presence of an optional noise capacitor (Section 3.3.3), permanently wired accessories, or presence of an external GFI. However, this voltage is not a problem and is a result of using a high-impedance meter to measure AC voltages.

3.6 INSTALLATION COMPLETION

Prior to operating the unit in the aircraft, it is recommended to verify the output and functionality of the unit. In order to prevent accidental damage to other systems, it is best not attach the output to other equipment or power busses prior to verification.

Verify the output of the unit at the terminating end of the cable with a multi-meter to ensure proper voltage and polarity. Once verified, installation can be completed and functionality of the remote on/off feature (if used) should be checked.

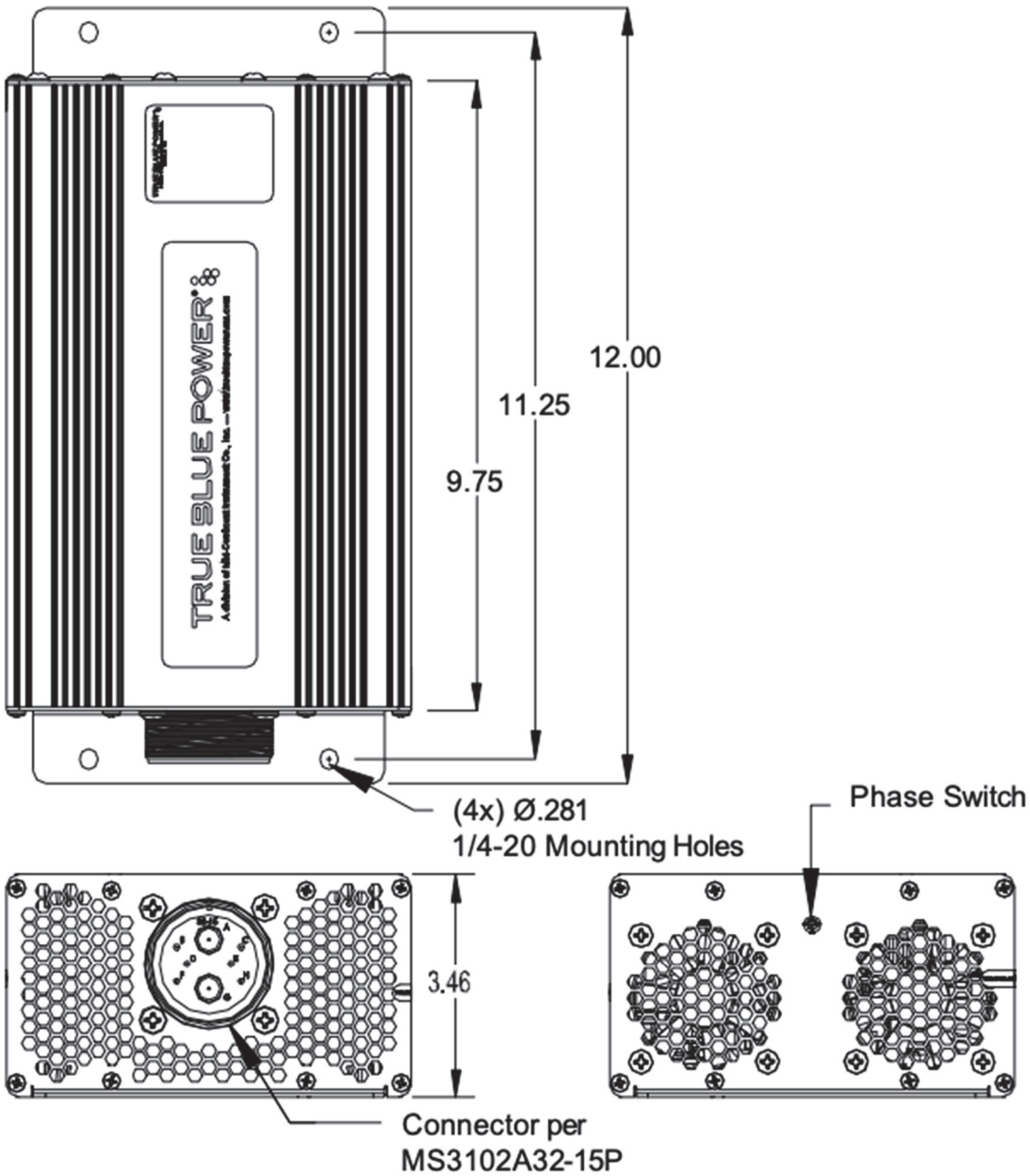

Fan Air Exhaust at connector End Fan Air Intake at this end of Inverter

Figure 3.5
TI2000 Series Outline Drawing

SECTION 4 OPERATION

4.1 ELECTRICAL PERFORMANCE

The TI2000 Series Static Inverter converts a direct current (DC) voltage input to a regulated, pure sine wave alternating current (VAC) output. Different models provide for outputs of 115 VAC 60 or 400 Hz, and 230 VAC 50 Hz. The unit is capable of providing 2000 watts to power a variety of aircraft accessories including laptops, personal electronics, onboard systems, and many others (See Table 1.2 for tolerance ranges).

The unit is designed as a two-stage, solid-state switch-mode power supply. The power transformation utilizes a first-stage push-pull methodology followed by an H-bridge AC forming second stage. The primary stage utilizes 'current-mode' control providing instantaneous load protection as an advantage over legacy designs that incorporate 'voltage-mode' controllers. The alternating current is frequency controlled using a crystal oscillator reference.

4.2 PROTECTIVE FEATURES

4.2.1 Remote On/Off

The TI2000 Series Static Inverter incorporates a remote on/off feature that allows the user to enable or disable the output of the unit. By providing a ground on the appropriate pin (See Table 3.3) the user, via a remote mounted switch or similar method, can enable the output of the unit. The unit can be similarly disabled by removing the ground signal (open circuit) to the same pin.

4.2.2 Over-Voltage

When the input voltage exceeds the operating range of the unit (See Table 1.1; absolute maximum input of 36VDC) the unit senses an over-voltage condition and disables the output. The unit will dynamically monitor the input voltage such that if the input returns to within the normal operating range, the output will be enabled and allow the unit to operate normally.

4.2.3 Under-Voltage

When the input voltage drops below the operating range of the unit (See Table 1.1; absolute minimum input of 20VDC) the unit senses an under-voltage condition and disables the output. The unit will monitor the input voltage such that if the input returns to within the normal operating range, the output will be enabled and allow the unit to operate normally.

4.2.4 Over-Temperature

The TI2000 Series incorporates an internal temperature sensing device that provides monitoring and feedback to the control circuits. When the unit senses an internal condition that exceeds maximum temperature, the inverter output is disabled and the internal cooling fans will continue to operate. The unit output will be enabled when the temperature returns to within acceptable limits. This over-temperature reset occurs automatically without any external intervention required.

4.2.5 Short Circuit and Over-Current

The TI2000 Series is capable of surviving a short circuit or over-current event without permanent damage or effect to long-term reliability. The unit can provide over its rated power output up to 110% of rating or 2200 VA continuously. The power output is limited by temperature, input voltage and altitude as shown in Figure 2.1.

At full short circuit, the unit can momentarily provide 3200 VA. After 2 seconds, the AC sine wave output is clipped and the inverter will only draw around 10 amps from the 28V input. If the short circuit is removed within 8 seconds, the inverter will return to full power, otherwise the output will shut off until the enable or the power input is cycled off and on again.

4.2.6 Temperature Regulated Cooling

The unit is equipped with two internal brushless DC fans for cooling to extend the power range and long-term life. The fans are activated at a specified point determined by the continuous monitoring of the internal temperature. The fans operate very quietly to reduce the audible noise in any environment. The two fans provide independent redundancy for protection of the unit in the event that one becomes inoperative.

4.3 RATED OUTPUT AT ALTITUDE

The output power rating is affected by the combination of altitude and temperature, per Figure 4.1. Above 40,000 feet, an ambient temperature above 23°C will limit the output to less than full power. In all cases, the protection within TI2000 will automatically power off the unit to prevent any damage should any condition cause high internal temperatures.

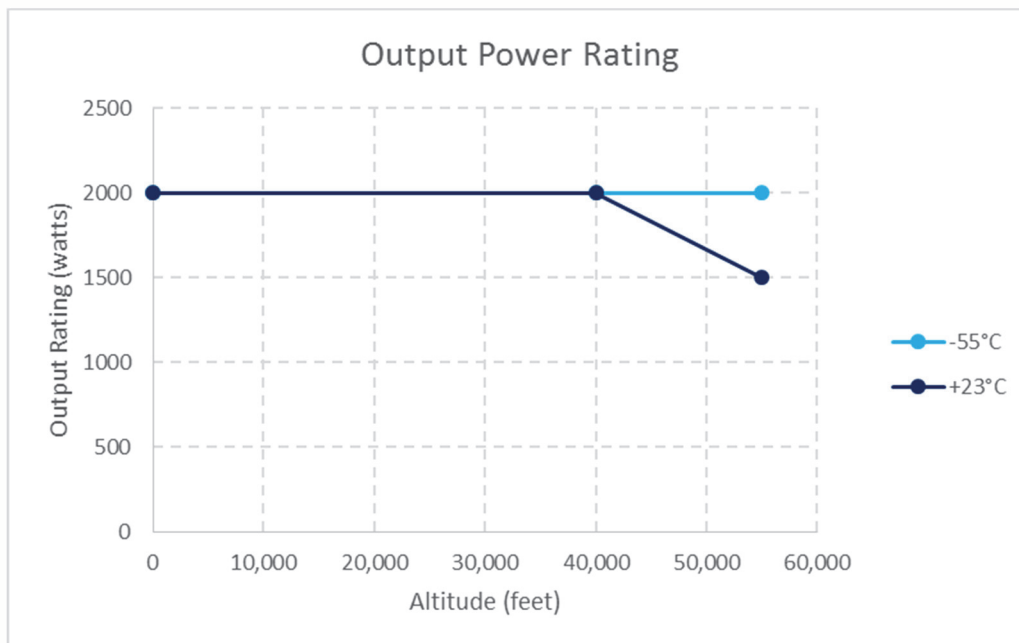

Figure 4.1 – Output Power Rating

SECTION 5 CONFORMANCE

5.1 INSTRUCTIONS FOR CONTINUED AIRWORTHINESS

No periodic scheduled maintenance or calibration is necessary for continued airworthiness of the TI2000 Series Static Inverter. If the unit fails to perform to specifications, the unit must be removed and serviced by Mid-Continent Instruments and Avionics or their authorized designee.

5.2 ENVIRONMENTAL QUALIFICATION STATEMENT

MODEL NUMBER: TI2000, TI2002, TI2004 **PART NUMBER:** 6432000-() Series
DESCRIPTION: Static Electrical Power Inverter **CERTIFICATION:** FAA TSO-C73
MANUFACTURER: True Blue Power, a division of Mid-Continent Instrument Co., Inc.
ADDRESS: 9400 E. 34th St. North, Wichita, KS 67226, USA.
SPECIFICATION: Test Specification (TS) 710 Test Data Sheet (TDS) 710
STANDARD: RTCA DO-160, Rev G, dated 12/08/10

CONDITIONS	SECTION	DESCRIPTION OF TEST
Temperature and Altitude	4	Category F2
Temperature Variation	5	Category S2
Humidity	6	Category B
Operational Shock and Crash Safety	7	Category B
Vibration	8	Category U; Curve G
Explosion	9	Category X
Waterproofness	10	Category X
Fluids	11	Category X
Sand and Dust	12	Category X
Fungus	13	Category X
Salt Spray	14	Category X
Magnetic Effect	15	Category Z
Power Input	16	Category B(XX)
Voltage Spike	17	Category B
Audio Frequency Conducted Susceptibility	18	Category R
Induced Signal Susceptibility	19	Category X
Radio Frequency Susceptibility	20	Category X
Emission of Radio Frequency Energy	21	Category B
Lightning Induced Transient Susceptibility	22	Category X
Lightning Direct Effects	23	Category X
Icing	24	Category X
ESD	25	Category A
Flammability	26	Category X

REMARKS: